

CPUボード <-> IOボード

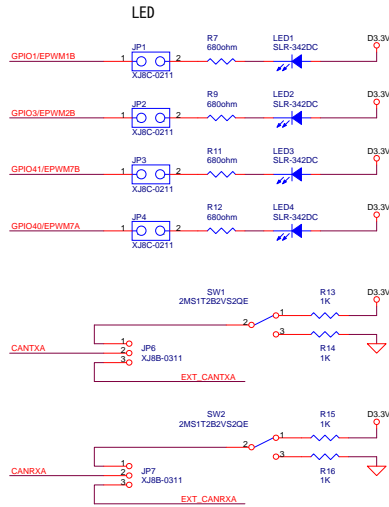

トグルスイッチ

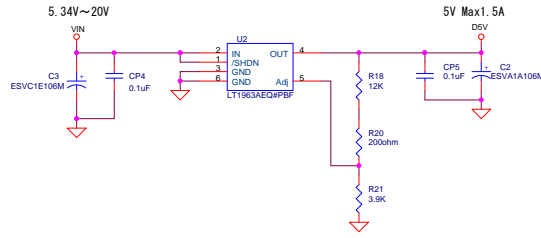
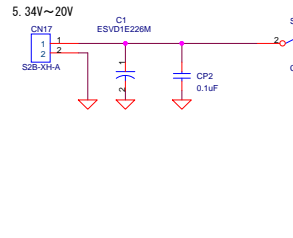

AINコネクタ (5V入力=3V)

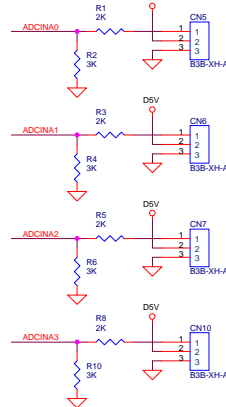

GPIOコネクタ

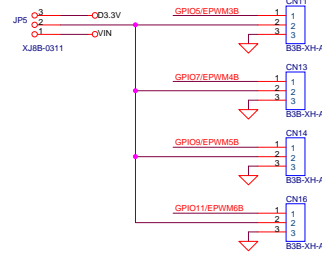

モーターボード <-> IOボード接続 コネクタ

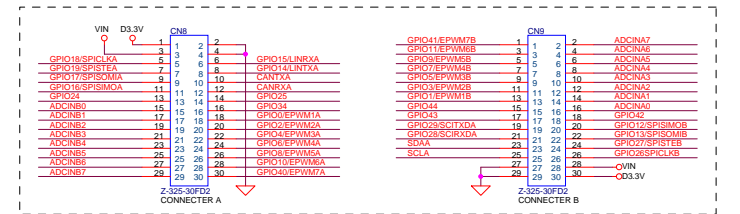
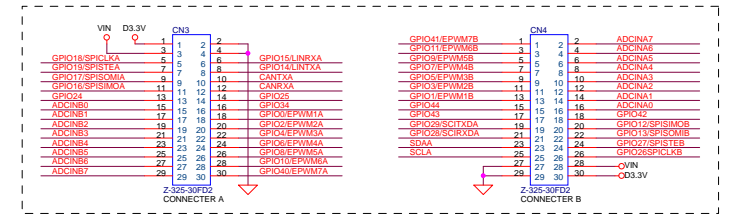

LCD用コネクタ

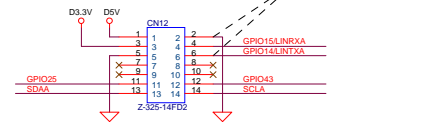

EQEPコネクタ

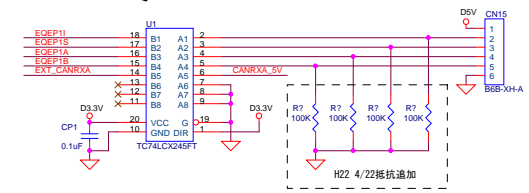

電源確認LED

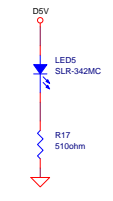

CAN通信コネクタ

